

Jacquard Sampling

evergreen II J

Jacquard sampling loom

Evergreen II J is especially designed to meet demand for weaving all types of Jacquard textile samples. It can comply with major electronic jacquard machine and allow complex patterns weaving and rapid time to market by removing the hassle of running on mass production machine. In addition, the integrated interface that combines jacquard and loom controllers is set to make the best management and interconnectivity of the machine. A human machine interface is equipped to make operation easy and enhance worker productivity. With the highly modern automation technology, Evergreen II J substantially helps elevate the overall working efficiency. It is mostly suitable for use in educational & research institute and sampling workshop, which don't have their own production loom.



Electronic Jacquard Machine

Jacquard Driving Motor
(No cardan shaft is required)

1344 & 2688 Hooks

Harness with Double
Comber Board

Reduced Height due to Compact
& Integrated Gantry Design

Integrated Interface

Single Side Rapier

Touch Screen and Windows
Embedded Controller



Options for 500 & 900 mm Width

Speed: 100 ppm max.

Evergreen II J500 (1344 hooks)

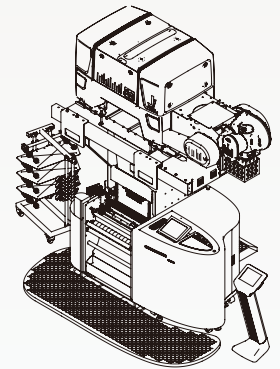
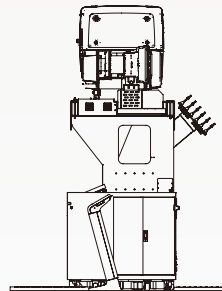
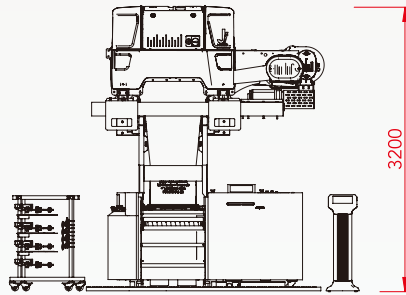
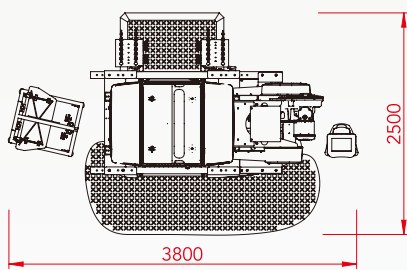

Evergreen II J900 (2688 hooks)

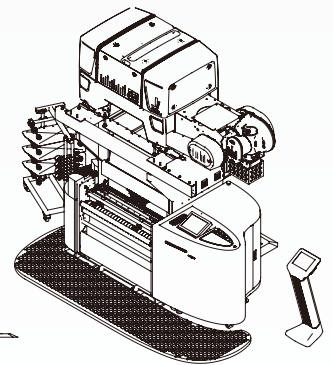
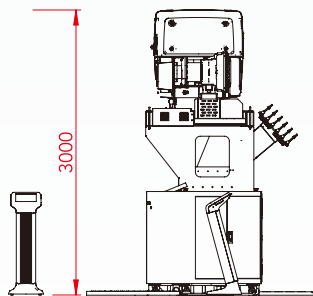
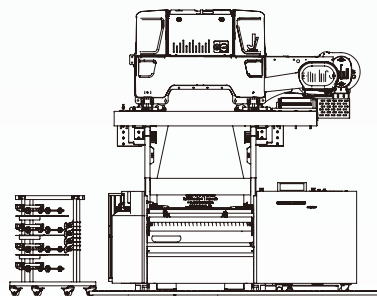
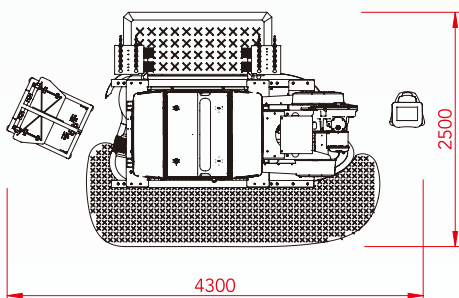

Unit: mm



E-mail: info@ccitk.com

* CCI has a policy of continuous product development and may make changes in the specification or appearance of the equipment without notice.
* Other product and company names mentioned herein may be trademarks or tradenames of their respective owners.

